

## canalización eléctrica prefabricada MS

### Dimensiones

#### Elementos rectos

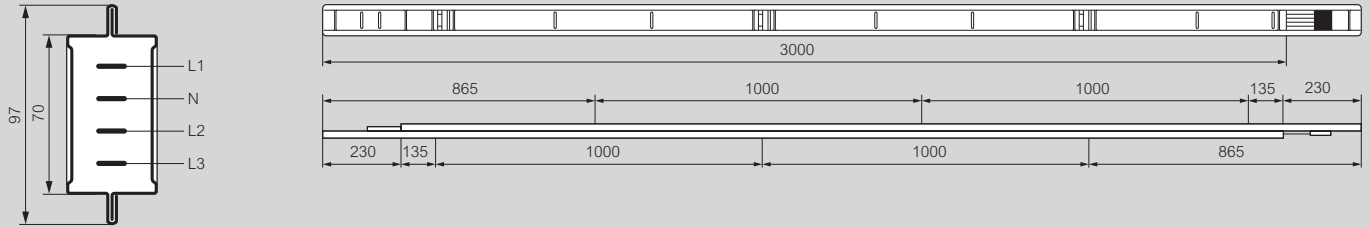

#### Ángulo horizontal

Tipo A: refs. 51153 03 51 / 5150 03 61 / 5152 03 51

Tipo B: refs. 5153 03 61 / 5150 03 62 / 5152 03 61

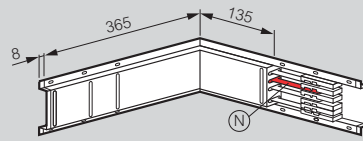
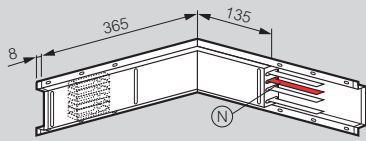

#### Ángulo vertical

Tipo A: refs. 5153 04 51 / 5150 04 61 / 5152 04 51

Tipo B: refs. 5153 04 61 / 5150 04 62 / 5150 04 61

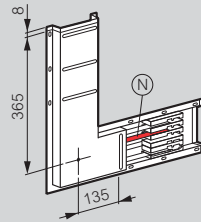
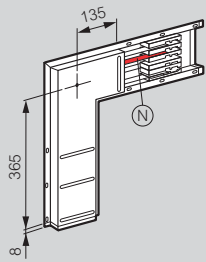

#### Caja de acometida

Refs. 5151 10 51 / 5151 10 52

Refs. 5152 10 51 / 5152 10 52

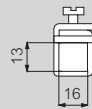
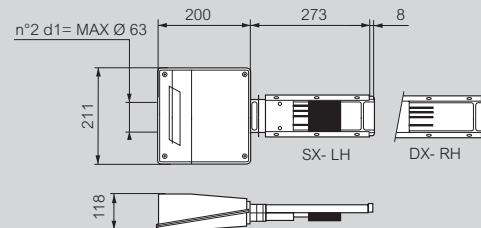
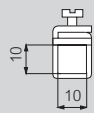
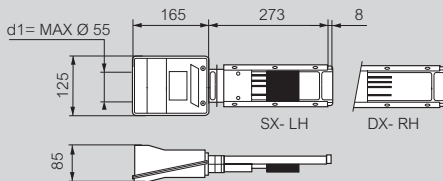

Ref. 5151 11 51

Ref. 5152 11 51

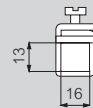
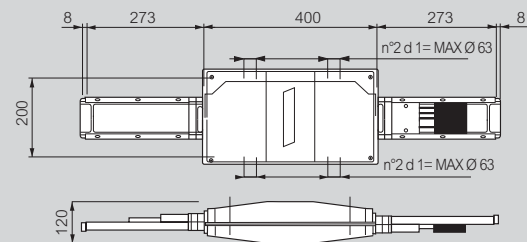
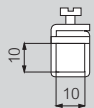
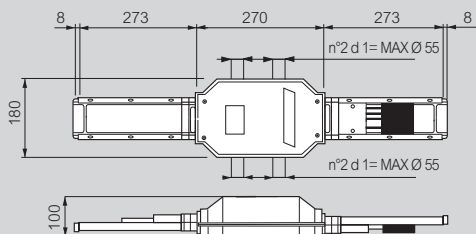

## ■ Dimensiones (continuación)

### Cajas de derivación

Refs. 5151 50 76 / 5151 50 71 / 5151 50 72

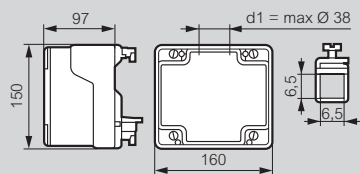

Refs. 5151 50 73 / 5151 50 74 / 5151 50 75

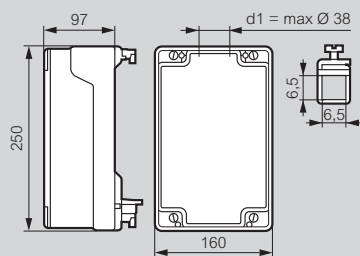

Ref. 5151 50 51

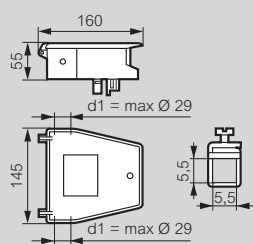

Ref. 5151 50 52

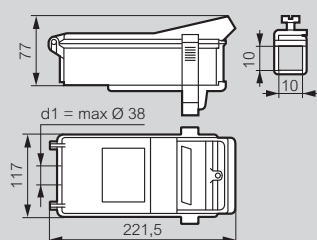

Refs. 5151 50 57 / 5151 50 67

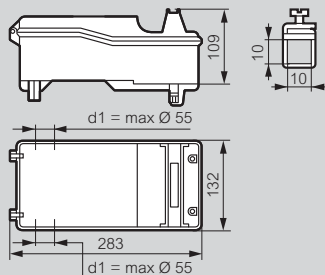

Ref. 5151 50 58

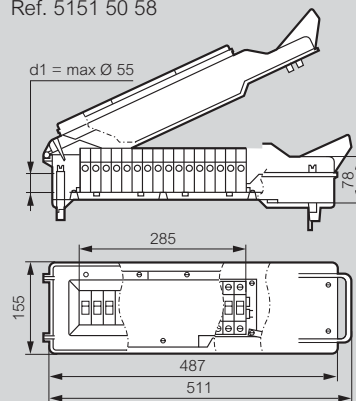

### Brida de suspensión

Ref. 5100 20 02

