

Modular safety isolating and bell transformers

Cat number(s): 4 130 90/91/92/93
4 130 95/96/97/98

SUMMARY PAGES

1. Operating principle	1
2. General characteristics.....	1
3. Ranges	1 to 2
4. Technical characteristics	2
5. Electrical characteristics.....	2
6. Miscellaneous.....	2

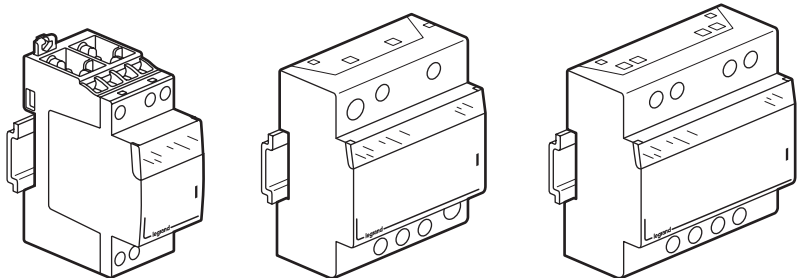

1. OPERATING PRINCIPLE

a. Safety isolating transformer: designed to protect people from electric shocks by using extra low voltage (ELV $U_{sec} \leq 50V$).

Power to 12 or 24V devices such as:

- relay
- modular power contactor
- signaling unit
- latching relay
- ...

Cat number 4 130 95/96

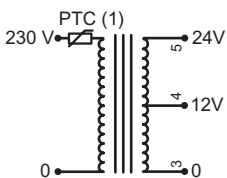

Cat number 4 130 97/98

Secondary 12V parallel coupling

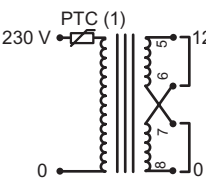

Secondary 24V serial coupling

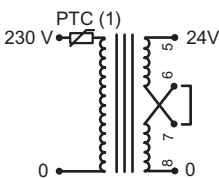

Connexion busbars supplied with the transformer

b. Bell transformer: safety isolating transformer with secondary voltage not permanently exceeding 24V and for a non permanent using.

Power to 8V-12V or 24V access control devices such as:

- bell
- chime
- door release
- optical/electrical barrier
- ...

Also:

- flood detector
- temperature rise detector

Cat number 4 130 90

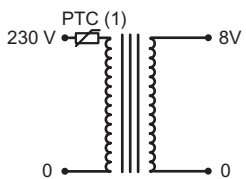

Cat number 4 130 91/92

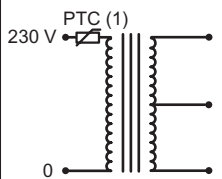

Cat number 4 130 93

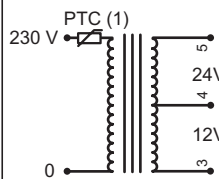

(1) PTC refer to general characteristics

2. GENERAL CHARACTERISTICS

Single phase 50/60 Hz

Input voltage 230 V

Protected against involuntary or accidental contact with live parts xxB

Class II under faceplate in distribution board

AC primary and secondary voltages

2.1 Standards and Conformities

Safety Isolating transformer IEC 61558-2-6 agreement



Bell transformer IEC 61558-2-8 agreement

Comply with French regulations ERP (buildings receiving members of general public) and IGH (high rise buildings)

CE Marking

2.2 Protection of transformers

Protected against overloads and short-circuits by built-in PTC (Positive coefficient of temperature) into primary winding.

In the event of an overload, switch off power supply and allow the transformer to cool down before switching on again.

3. RANGES

3.1 Safety isolating transformer

Primary 230 V, secondary 12 V / 24 V.

Rating (VA)	Catalogue number	Number of modules
16	4 130 95	4
25	4 130 96	4
40	4 130 97	5
63	4 130 98	5

3.2 Bell transformer

Primary 230 V.

Secondary voltage (V)	Current (A)	Rating (VA)	Cat number	Number of modules
8	0.5	4	4 130 90	2
8/12	1/0.66	8	4 130 91	2
8/12	3/2	24	4 130 92	4
12/24	1.5/1	18/24	4 130 93	4

Modular safety isolating and bell transformers

Cat number(s): 4 130 90/91/92/93
4 130 95/96/97/98

For models 4 130 90 – 4 130 91 (2 modules)

Possibility for supply busbar to run through on upper side of device.
On lower side, allow the supply of primary terminals straight from protective using single phase and neutral comb prong:

2 prong, mcb on left side

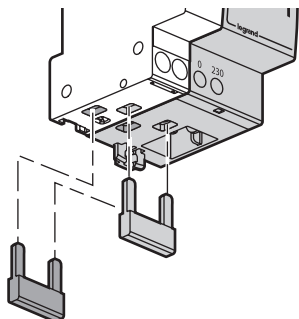

3 prong, mcb on right side

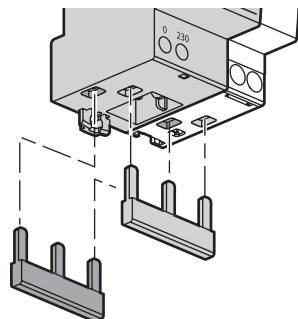

4. TECHNICAL CHARACTERISTICS

4.1 Identification

Excellent durability of data pad printed on front cover:

- reference number,
- primary and secondary voltages
- ratings => safety isolating transformers,
- secondary currents => bell transformers,
- conformity to standards,
- connection diagram (depending on model),
- type (bell or safety),
- terminal identification (depending on model).

4.2 Fixing/dimensions

Wall or rail din \surd 7.5 or 15 mm* depth for 4 module units.

Rail din \surd 7.5 or 15 mm* depth for 2 and 5 module units.

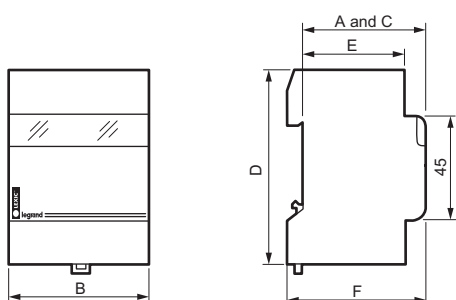

Cat number	Dimensions (mm)					
	A	B	C	D	E	F
4 130 90	60	36	60	84	44	66
4 130 91	60	36	60	84	44	66
4 130 92	60	72	60	84	44	66
4 130 93	60	72	60	84	44	66
4 130 95	60	72	60	84	44	66
4 130 96	60	72	60	84	44	66
4 130 97	60	89	60	95	44	66
4 130 98	60	89	60	95	44	66

(*) Unclipable with tool

4.3 Connection

	Primary flexible or rigid	Secondary flexible or rigid
	1 to 4 mm ²	1 to 4 mm ²

4.4 Identification

Label holder on front cover. Suitable with any Lexic range label.

4.5 Materials

Mineral added 6/6 polyamid casing.
Transparent polycarbonate label holder.
Polyamide or polyacetal clamp.

5. ELECTRICAL CHARACTERISTICS

Safety isolating transformer

Cat number	Rating (VA)	No load losses (w)	Voltage drop (%) cos Φ = 1	Efficiency cos Φ = 1	Ucc %	Loaded primary current (A)
4 130 95	16	2.5	34.6	0.60	27.5	0.10
4 130 96	25	2.5	29	0.66	23.3	0.14
4 130 97	40	4	17.9	0.68	14.4	0.22
4 130 98	63	4	15.7	0.75	13.6	0.33

6. MISCELLANEOUS

Heating value (Mega Joule)

Bell transformer

Cat number	4 130 90	4 130 91	4 130 92	4 130 93
H. value (MJ)	5.6	6.3	11.3	11.4

Isolating safety transformer

Cat number	4 130 95	4 130 96	4 130 97	4 130 98
H. value (MJ)	12.2	12.2	14.6	15.5